

1W 730nm High Power IR LED Technical Data Sheet

Part No.: DL-HP10VIRA-1W



Double Light

◆ Features:

1. Very long operating life (up to 100k hours).
2. Available in white, green, blue, red, yellow.
3. More energy efficient than incandescent and most halogen lamps.
4. Low voltage DC operated.
5. Cool beam, safe to the touch.
6. Instant light (less than 100 ns).
7. The product itself will remain within RoHS compliant Version.

◆ Applications:

1. Reading lights (car, bus, aircraft).
2. Portable (flashlight, bicycle).
3. Mini_accent/Uplighters/Downlighters/Orientation.
4. Bollards/Security/Garden.
5. Cove/Undershelf/Task.
6. Automotive rear combination lamps.
7. Traffic signaling/Beacons/ Rail crossing and Wayside.
8. Indoor/Outdoor Commercial and Residential Architectural.
9. Edge_lit signs (Exit, point of sale).
10. LCD Backlights/Light Guides.

Double Light

◆ Mechanical Dimensions:

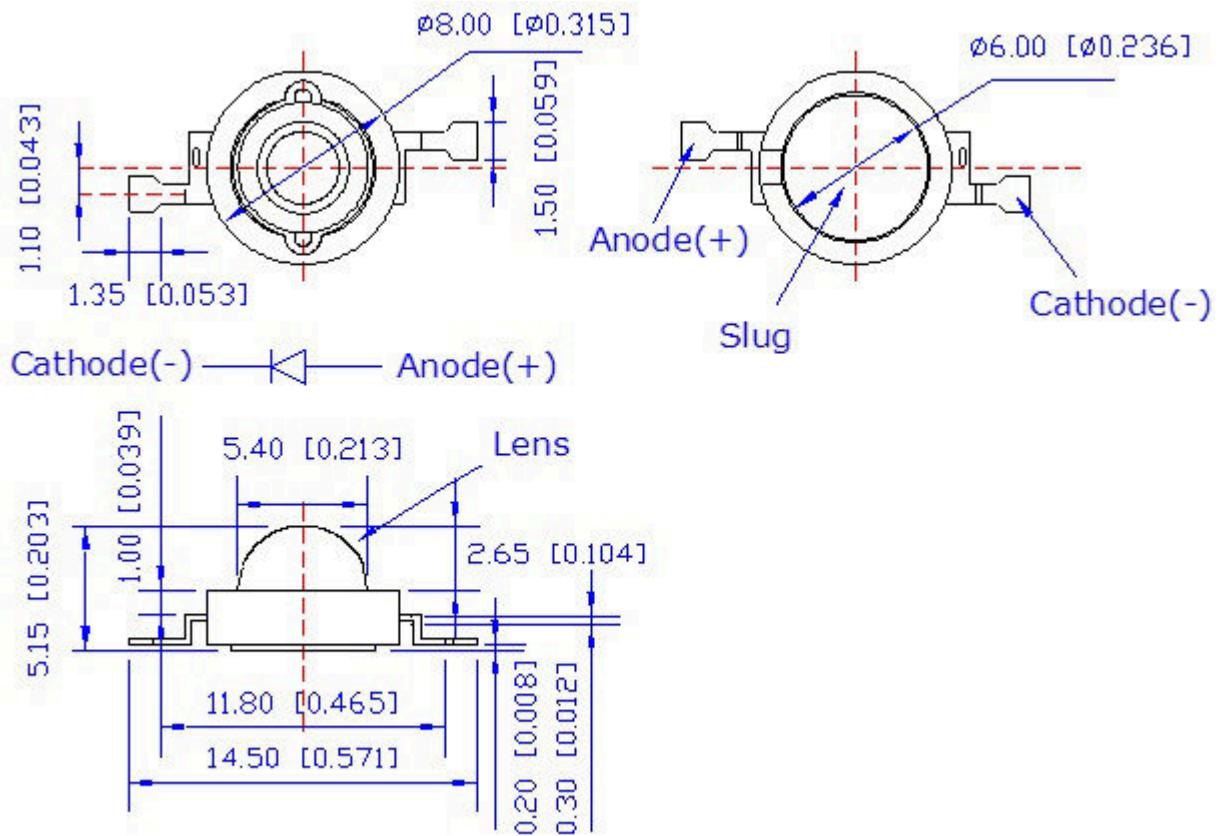

Part No.	Chip Material	Source Color
DL-HP10VIRA-1W	GaAlAs	730NM

Notes:

1. All dimensions are in millimeters.
2. Tolerance is ± 0.25 mm (.010") unless otherwise noted.

Double Light

◆ Absolute Maximum Ratings at Ta=25°C

Parameters	Symbol	Rating	Units
Forward Current	I_F	500	mA
Peak Pulse Current ($t_p \leq 100\mu s$, Duty cycle=0.25)	I_{pulse}	700	mA
Reverse Voltage	V_R	5	V
LED Junction Temperature	T_j	125	°C
Operating Temperature Range	T_{opr}	-40 to +80	°C
Storage Temperature Range	T_{stg}	-40 to +100	°C
Soldering Time at 260°C (Max.)	T_{sol}	5	Seconds

Notes:

1. Proper current derating must be observed to maintain junction temperature below the maximum.
2. LEDs are not designed to be driven in reverse bias.

Electrical Optical Characteristics at Ta=25°C

Parameters	Symbol	Min.	Typ.	Max.	Unit	Test Condition
Viewing Angle [1]	$2\theta_{1/2}$	---	120	--	Deg	IF=350mA
Forward Voltage [2]	V_F	1.6	---	2.2	V	IF=350mA
Reverse Current	I_R	---	---	10	μA	$V_R=5V$
Peak Emission Wavelength	λ_p	---	730	---	nm	IF=350mA
Dominant Wavelength	λ_d	----	730	----	nm	IF =350mA
Spectrum Radiation Bandwidth	$\Delta\lambda$	---	10	---	nm	IF=350mA
Power Intensity	P_v	160	---	240	mw	IF=350mA

Notes:

1. $2\theta_{1/2}$ is the off axis angle from lamp centerline where the luminous intensity is 1/2 of the peak value.
2. Forward Voltage measurement tolerance : $\pm 0.1V$

Double Light

◆ Typical Electrical / Optical Characteristics Curves

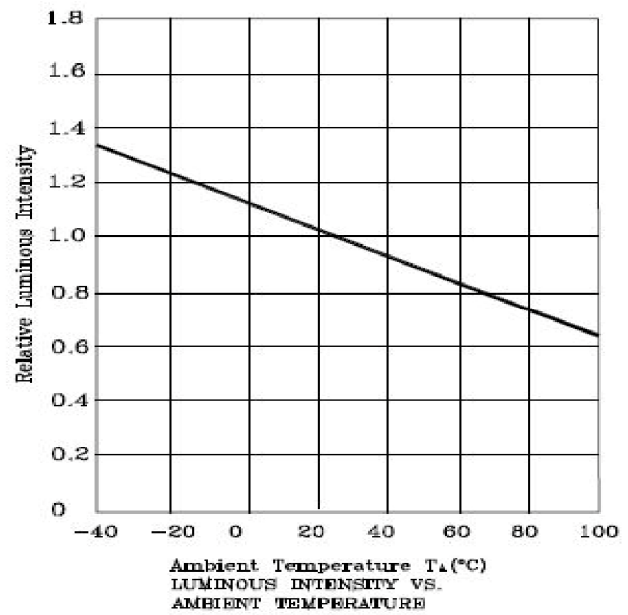
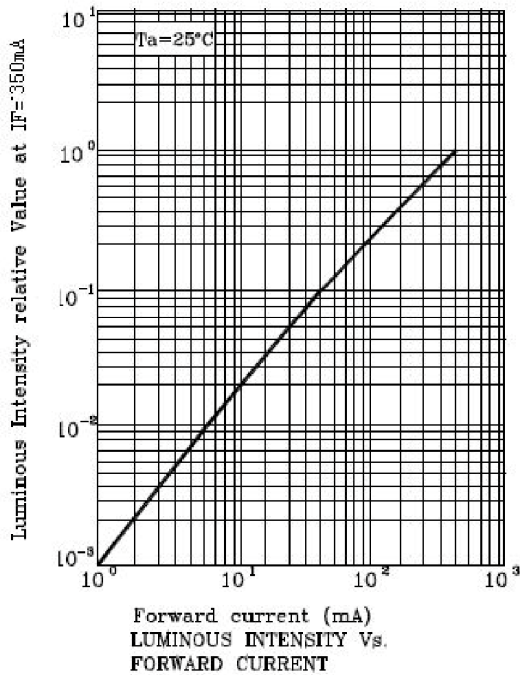
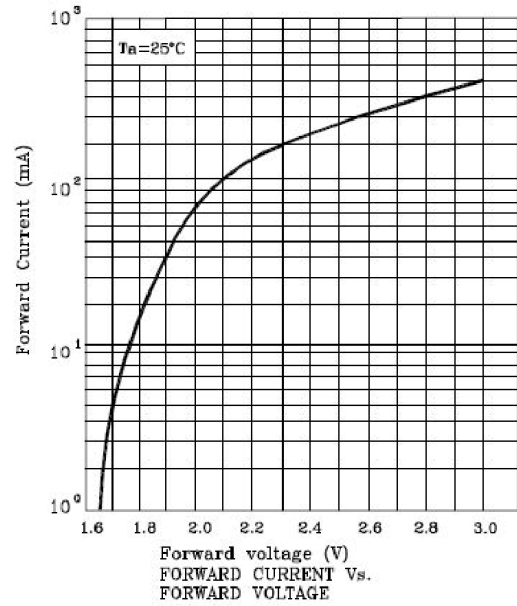
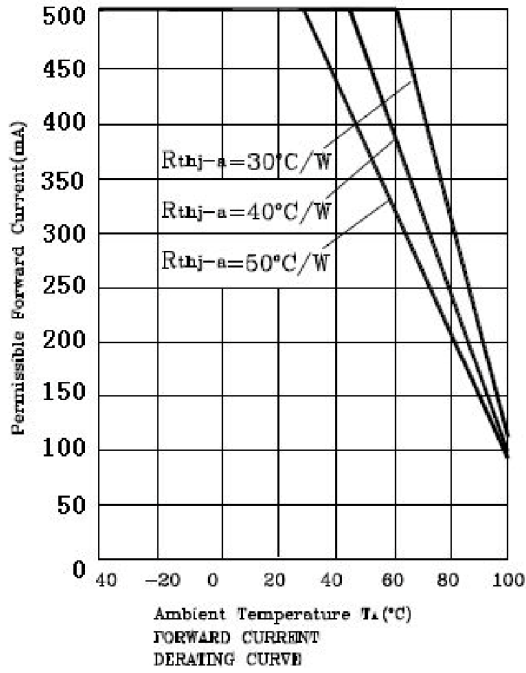

Double Light

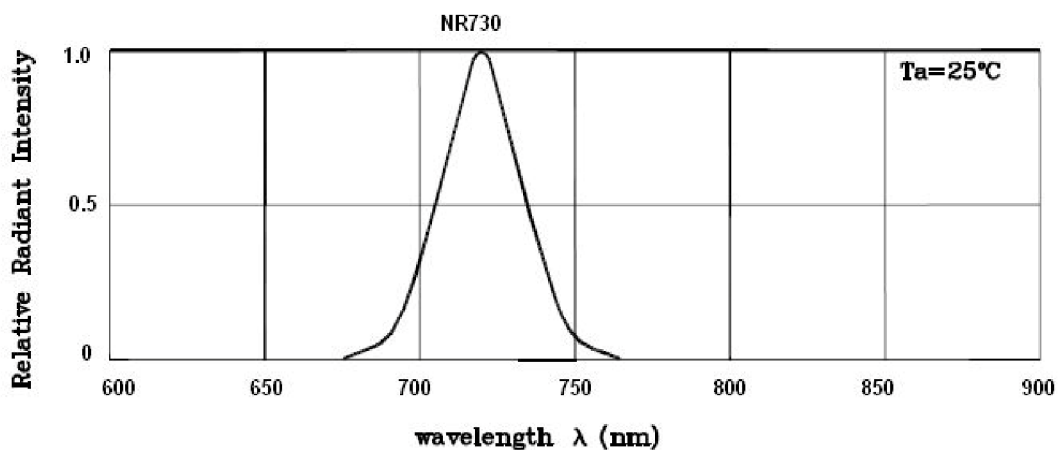

RELATIVE INTENSITY Vs. WAVELENGTH

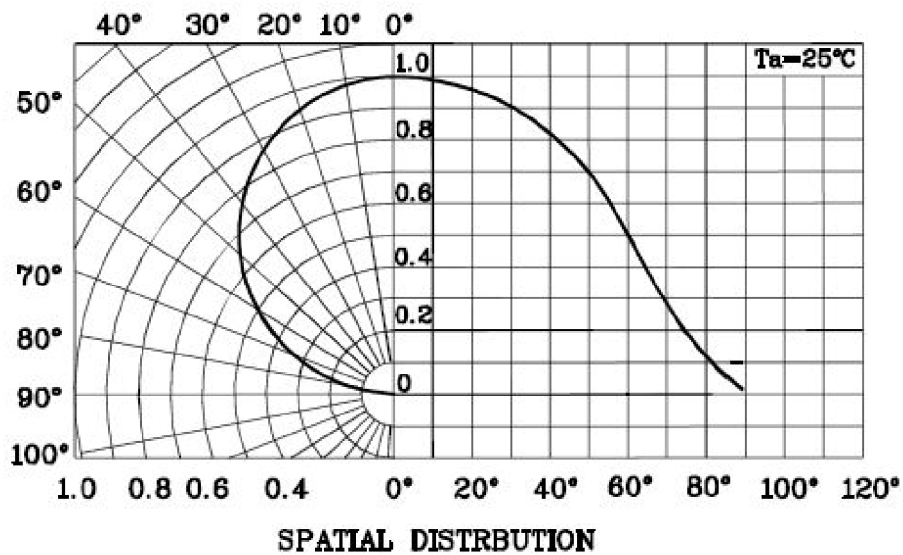

Double Light

◆ Reliability Test Items And Conditions:

The reliability of products shall be satisfied with items listed below:

Confidence level: 90%.

LTPD: 10%.

1) Test Items and Results:

No.	Test classification	Test Item	Test conditions	Test Hour/Cycle	Sample Size	Ac/Re
1	Life test	Room temperature DC operating life test	Ta=25±5°C IF=350mA	1000hrs	60pcs	0/1
2	Environment test	Thermal Shock Test	-10±5°C ↔ +100±5°C 5min 10sec 5min	50cycles	60pcs	0/1
		Temperature Cycle Test	-10±5°C ↔ +100±5°C 30min 5sec 30min	50cycles	60pcs	0/1
		High Temperature & High humidity test	Ta=85±5°C RH=85%±0.5%RH	1000hrs	60pcs	0/1
		High temperature storage	Ta=100±5°C	1000hrs	60pcs	0/1
		Low Temperature Storage	Ta=55±5°C	1000hrs	60pcs	0/1
3	Mechanical test	Resistance to soldering heat	Ta=230±5°C	5sec	60pcs	0/1
		Lead integrity	Load 2.5N (0.25KG) 0°C ~ 90°C ~ 0°C	3times	60pcs	0/1

2) Criteria for Judging the Damage:

Item	Symbol	Test Conditions	Criteria for Judgment	
			Min	Max
Forward Voltage	VF	IF = 350mA	---	F.V.*)×1.1
Reverse Current	IR	VR=5V	---	F.V.*)×2.0
Luminous Intensity	IV	IF = 350mA	F.V.*)×0.7	---

*) F.V.: First Value.

Double Light

◆ Precautions For Use:

1. Over-current-proof

Though HP10 has conducted ESD protection mechanism, customer must not use the device in reverse and should apply resistors for extra protection. Otherwise slight voltage shift may cause enormous current change and burn out failure would happen.

2. Storage

- 1) Do not open moisture proof bag before the products are ready to use.
- 2) Before opening the package, the LEDs should be kept at 30°C or less and 90%RH or less.
- 3) The LEDs should be used within a year.
- 4) After opening the package, the LEDs should be kept at 30°C or less and 70%RH or less.
- 5) The LEDs should be used within 168 hours (7 days) after opening the package.
- 6) If the moisture absorbent material (silicone gel) has faded away or the LEDs have exceeded the storage time, baking treatment should be performed using the following conditions.
- 7) Pre-curing treatment: 60±5°C for 24 hours.

3. Thermal Management

- 1) Because HP10 LED is a high power dissipation device, special and sufficient consideration in thermal management design must be made to optimize the thermal performance.
- 2) Heat sink design is implemented in the device for an additional thermal connection. Since the device is capable of SMT process, tin must be spread both heat sink and solder pads areas to dissipate the heat.
- 3) A high thermal conductivity substrate, such as Aluminum or Copper plate etc, must be applied for external thermal management. It is strongly recommended that the outer heat sink or PCB dimension per LED cannot be less than 25 x 25 x 1 (L x W x H) mm. The materials for outer heat sink can be FR4 on Aluminum, MCPCB, or FPC on Aluminum.
- 4) Special thermal designs are also recommended to take in outer heat sink design, such as FR4 PCB on Aluminum with thermal vias or FPC on Aluminum with thermal conductive adhesive, etc.
- 5) Sufficient thermal management must be conducted, or the die junction temperature will be over the limit under large electronic driving and LED lifetime will decrease critically.

4. Soldering Condition

- 1) Soldering should not be done more than two times.
- 2) While soldering, do not put stress on the LEDs during heating.
- 3) After soldering, do not warp the circuit board.

5. Soldering Iron

- 1) For prototype builds or small series production runs it is possible to place and solder the LED by hand.
- 2) Dispensing thermal conductive glue or grease on the substrates and follow its curing spec. Press LED housing to closely connect LED and substrate.
- 3) It is recommended to hand solder the leads with a solder tip temperature of 280°C for less than 3 seconds within once in less than the soldering iron capacity 25W. Leave two seconds and more intervals, and do soldering of each terminal.
- 4) Be careful because the damage of the product is often started at the time of the hand solder.